

- ^{ぶんどき}分度器の中心を点アに合わせて次の角度をかきましょう。

1 120°

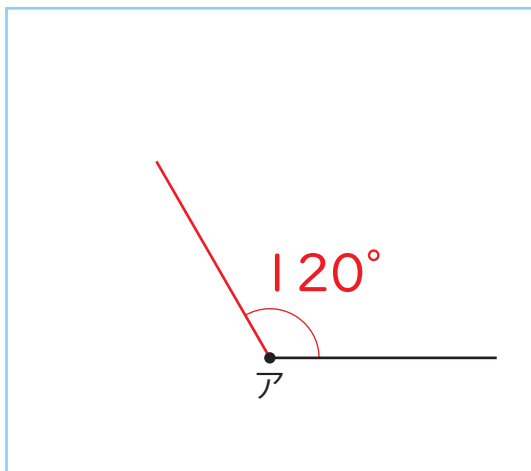

2 145°

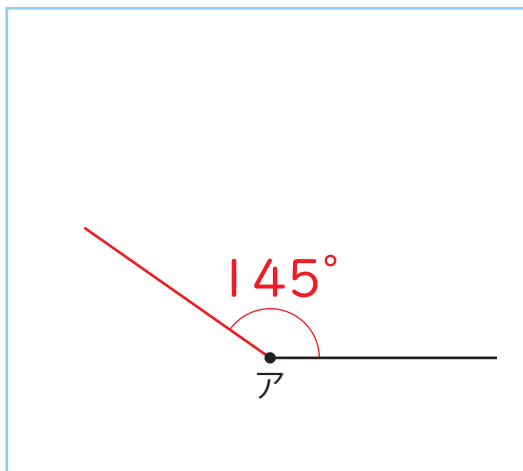

3 175°

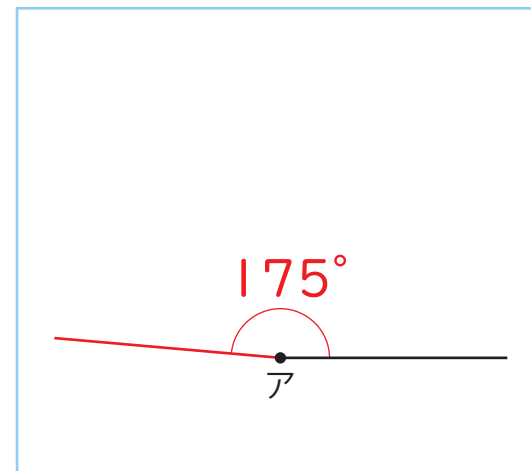

4 135°

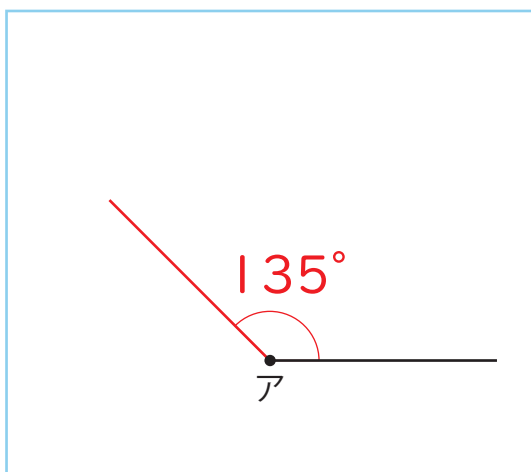

5 170°

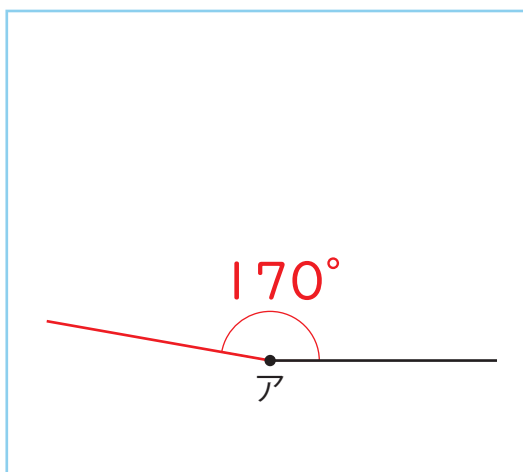

6 95°

